

1

2

3

4

A

A

B

B

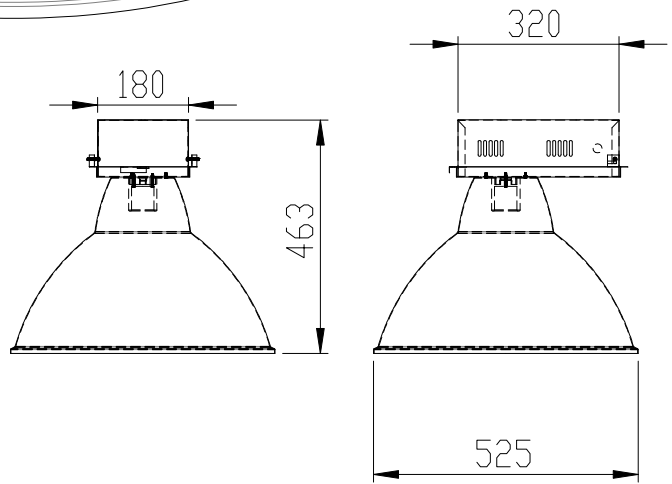
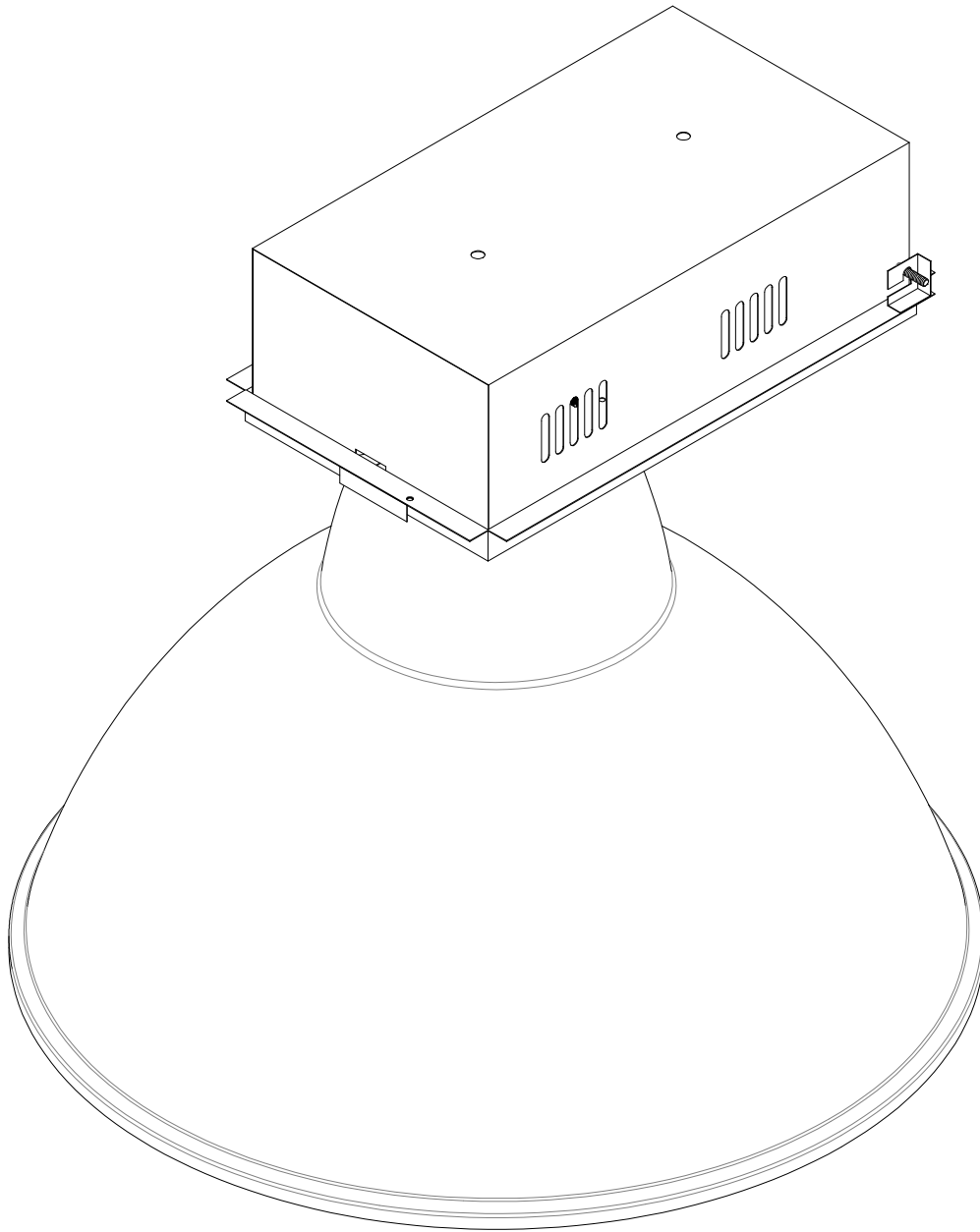

C

C



D

D

PEÇA	DENOMINAÇÕES E ESPECIFICAÇÕES	QTD.	MATERIAL E DIMENÇÕES
	TÍTULO <h1 style="text-align: center;">PL 421</h1>	UNIDADE mm PROJEÇÃO 	
	PROJETA DANIEL SILVA FRANÇA	ESCALA 1 : 15 DATA 18/05/2010	

1

2

3

4